



Modelli 15329A

project name:

project location:

specifier name:

specifier location:

quantity:

fixture type:

modifications:

Base Specs

14.5"h x 14"w x 3.75"d

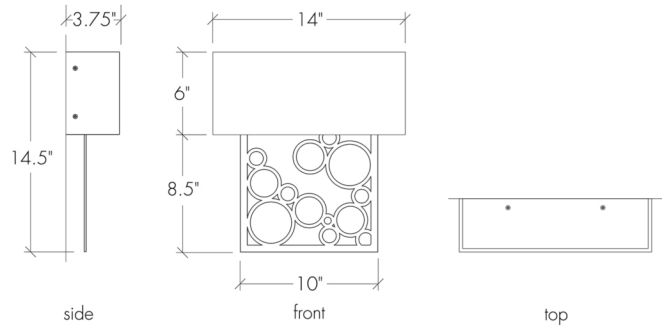



Modelli 15329A

standard finish:

BA - Bronze Age
BK - Black
BP - Black Pearl
CB - Cast Bronze
CH - Chestnut
CR - Chrome
DI - Dark Iron
EB - Empire Bronze
MB - Medieval Bronze
NB - New Brass
SB - Smokey Brass
SP - Satin Pewter
SS - Smoked Silver

lampping:

04: 14w Integrated LED, 2198 Initial Lumens, 3000K, 90 CRI, 120V-277V, 0-10V Dimming, UL/cUL Dry/Damp

14: 8.4w Integrated LED, 1181 Initial Lumens, 3000K, 90 CRI, 120V, Standard Phase Dimming, UL/cUL Dry/Damp

standard diffuser:

OA - Opal Acrylic

premium diffuser:

CO - Caramel Onyx
FA - Faux Alabaster
TS - Tea Stained
WS - White Swirl

